



Shenzhen Ateess Power Technology Co.,Ltd

3rd floor, building 9, Henglong industrial park, the fourth industrial zone of Shuitian community,
Baoan district, Shenzhen, China

T + 86 755 2998 8492

E info@atesspower.com

W www.atesspower.com

ATESS PBD250/350

Solar charge controller User Manual

Contents

1 About this Manual

- 1.1 Contents
- 1.2 Target readers
- 1.3 How to use this manual

2 Safety instructions

- 2.1 Symbols explanation
- 2.2 Notice for use
- 2.3 Installation
- 2.4 Operation personnel
- 2.5 Important note

3 Product Description

- 3.1 Energy storage system
- 3.2 Circuit diagram of the controller
- 3.3 Layout of the main components
- 3.4 Operation mode
- 3.5 Note for load operation
- 3.6 Dimension and weight
- 3.7 Package information

4 Transportation and storage

- 4.1 Transportation
- 4.2 Inspection and storage

5 Products installation

- 5.1 Installation condition and requirements
- 5.2 Tools and spare parts required for whole machine installation
- 5.3 Mechanical installation
- 5.4 Electrical installation
- 5.5 Communication
- 5.6 Wiring for single/parallel system and CAN communication

6 Pilot operation

- 6.1 Inspection
- 6.2 Commissioning

7 GUI instruction

- 7.1 LCD display screen introduction
- 7.2 LCD operation
- 7.3 LCD display information schedule

8 Operation

- 8.1 Power on steps
- 8.2 Pilot operation completion
- 8.3 Power off steps

9 Routine maintenance

- 9.1 Regular maintenance
- 9.2 Waste disposal

10 Appendix

- 10.1 Specification
- 10.2 ATESS Factory warranty
- 10.3 Contact

1 About this Manual

This chapter describes the contents of this manual, target reader, and safety symbols, can help users to have a better understanding of the manual.

1.1 Contents

This manual applies to ATESS PBD250/350 Bidirectional battery controller, the manual contains:

➤ safety instruction

Attention that needs to be paid when operating and maintaining ATESS PBD model.

➤ Product description

The role controller plays in the energy storage system and structure, principle, protection, operation mode, storage and package size of the ATESS PBD model.

➤ Transportation and storage

The mode of transportation of the product and the related storage precautions notice.

➤ Installation

controller installation conditions, tools, and the controller mechanical and electrical installation, the communication connection and inspection.

➤ Commissioning

Inspection before commissioning.

➤ GUI(Graphic User Interface) instruction

Information displayed on the controller LCD touch-screen and setting instruction.

➤ Operation

Procedure to turn on/off controller.

➤ Routine maintenance

Daily maintenance of the controller, the replacement of some spare parts and waste disposal instruction.

➤ Appendix

Technical data, warranty policy and contact information etc..

1.2 Target readers

Qualification:

- Only professional electricians or professionally qualified personnel can transport or install this product.
- The operator should be fully familiar with the structure and working principle of the entire Energy Storage system;
- The operator should be fully familiar with this manual;
- The operator should be fully familiar with the local standards of the project.

1.3. How to use this Manual

Please read this manual carefully before installing or using the equipment. Please store this manual and the corresponding information with the product components together to ensure that the relevant personnel can easily access and use it.

The contents of the manual will be updated and revised constantly, and it is inevitable that there is a slight discrepancy or error between the manual and the real product. Users should contact their local distributors or login to our website: www.atesspower.com to download and obtain the latest version of the manual.

2 Safety instructions

2.1 Symbols explanation

In order to ensure the personal and property safety of the user during installation, or optimally efficient use of this product, symbols are used highlight the information. The following symbols may be used in this manual, please read carefully, in order to make better use of this manual.

	DANGER DANGER indicates a hazard with a high level of risk which, if not avoided, will result in death or serious injury.
	CAUTION CAUTION indicates there is potential risk, if not avoided, could result in equipment malfunction and property damage.
	Caution, risk of electric shock When battery bank connecting point are exposed, there will be DC voltage in the equipment DC side; and when output breaker is on, there is a potential risk of electric shock.
	Caution, risk of fire hazard Suitable for mounting on concrete or other non-combustible surface only.
	Protective conductor terminal The controller has to be firmly grounded to ensure the safety of personnel.
	Risk of electric shock, Energy storage timed discharge Electrical shock danger exists in the capacitor; the cover shall be moved at least 5 minutes later after all powers are disconnected.

2.2 Safety instructions

controller installation and service personnel must be trained and familiar with the general safety requirement when working on electrical equipment. Installation and service personnel should also be familiar with the local laws and regulations and safety requirements.

- Read this manual carefully before operation. The equipment will not be under warranty if failing to operate according to this manual.
- Operation on the controller must be for qualified electrical technician only.
- When controller operating, don't touch any electrical parts except for the touch-screen.
- All electrical operation must comply with local electrical operation standards.
- Permission from the local utility company is required before installing the PBD and only professional personnel are qualified for the operation

2.3 Installation

Proper installation requires following all the instructions in the user manual involving transportation, mounting, wiring and commissioning. ATESS does not cover warranty for the controller damage due to failing to use it properly.

The protection level of the controller is IP20, which is designed for indoor installation. Please refer to chapter 5 for installation instruction.

Other notice for using the controller:

- Pay attention to the safety instructions listed here and below;
- Pay attention to the user manual of energy storage controller;
- Technical data related to equipment shall be considered.

2.4 Operator

controller installation and service personnel must be trained and familiar with the general safety requirement when working on electrical equipment. Installation and service personnel should also be familiar with the local laws and regulations and safety requirements.

2.5 Important note



Item 1: Static electricity can cause damage to the controller electrostatic discharge may cause unrecoverable damage to controller internal components!
When operating the controller, operator must comply with anti-static protection norms!

Item 2: Restriction
The controller cannot be directly used to connect the life support equipment and medical equipment!

Item 3: Precautions
Make sure installation tools or other unnecessary items are not left inside the controller before starting up.

Item 4: Maintenance notice
Maintenance can only be carried out after the controller totally discharged.

3 Product description

3.1 Energy Storage system

ATESS PBD250/350 is designed for solar charge controlling, The main function is to distribute the photovoltaic DC power to the energy storage battery. Now it is commonly used with our PCS energy storage system, as shown in the following system diagram:

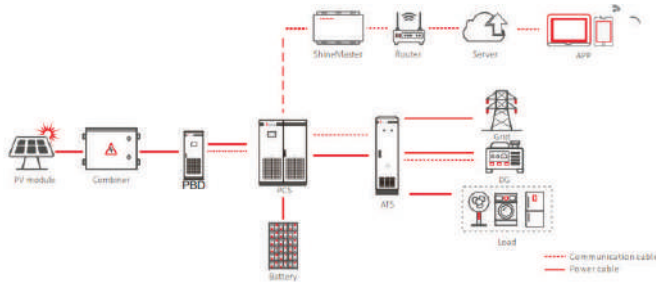

3.2 Circuit diagram of the controller

PBD350 is designed with two-stage BUCK step-up circuit, with batteries in the middle of the two stages and also in the output, which can be charged through voltage step-down; PBD250 is designed with one-stage BOOST step-down circuit, with batteries in the output, which can be charged through voltage step-up.

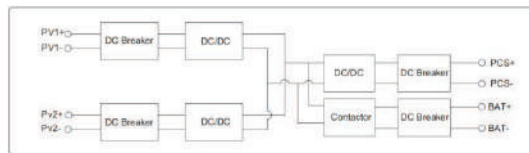

Circuit diagram of PBD350

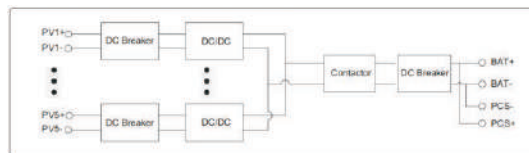

Circuit diagram of PBD250

3.3 Layout of the main components

3.3.1 External components

The main external components of PBD include: LED indicator, LCD touch screen, off-on knob, emergency stop button and other parts.

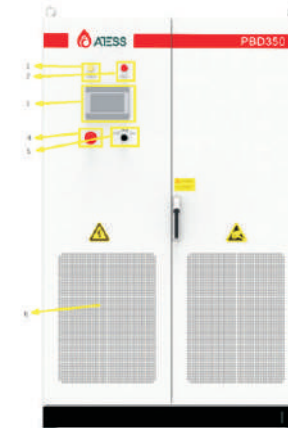

Appearance description of PBD

NO	Name	Description
1	Power indicator	When power supply is normal, the indicator displays yellow.
2	FAULT	When PBD is faulty, the indicator displays red.
3	Touch Screen LCD	Operation information display, receive control command and parameters setting
4	OFF/ON knob	Control on and off of PBD, turn to on when power on, and switch to off when power off
5	EMERGENCY STOP	Shut down PBD when pressed down
6	Dust screen	Prevent dust from entering into the controller

Part description

> Indicator

The energy storage controller adopts intelligent design. There are two LED indicators on the controller which is used to display the current status of the PBD.



LED indicators

LED	Description
POWER	The indicator lights when power supply to PBD is normal.
FAULT	The indicator lights when there is failure in circuit system.

LED indicator description

> Emergency STOP



The emergency stop button is only used in case of emergency, such as: fire, leakage, serious operation error and other situation requiring immediate shutdown!



Emergency STOP

The emergency stop button immediately disconnects the PBD from all the external connection, which ensure the safety of the controller. By pressing the emergency stop button, the device will be locked in the "off" position. Only after removing all faults, release the emergency stop button by rotating it clockwise, can the controller resume working normally.

> Off-on knob

It is used to start or stop the controller.

STOP RUN



Off-on knob

> Touch screen

It displays the controller's operating parameters, power generation, and faulty information record.

3.3.2 internal component

The internal components of PBD include: PV circuit breaker, battery circuit breaker, maintenance switch, load circuit breaker, power supply micro break, AC lightning protection switch, PCB, etc. Following is the structural drawing of pbd250 / 350 front and back side.

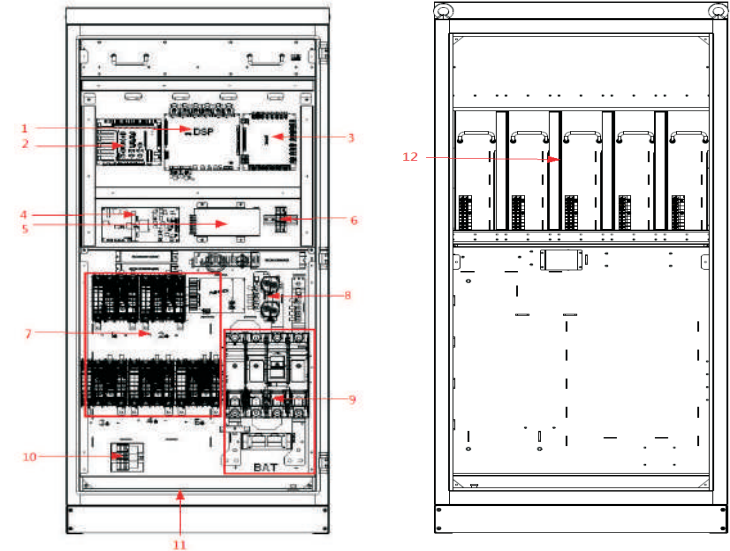

The front structural drawing of PBD250

The back structural drawing of PBD250

Model	PBD250	
NO	Name	Description
1	Control board	Main board includes communication interface
2	Sampling board	Voltage current temperature sampling PCB
3	Interface board	Power supply conversion PCB
4	BUCK board	Depressurize DC high voltage to supply power to PCB
5	Power source	Power supply for control board
6	Power supply micro break	Control board power supply switch
7	PV circuit breaker	Control the disconnection of PV with PBD
8	Main relay of battery	Pull in main relay after soft start
9	Battery circuit breaker	Control the connection between battery and PBD
10	AC fan switch	Control the connection of AC220
11	Earth terminals	Grounding bronze terminals
12	Module	5 modules including IGBT, capacitance, inductance, etc.

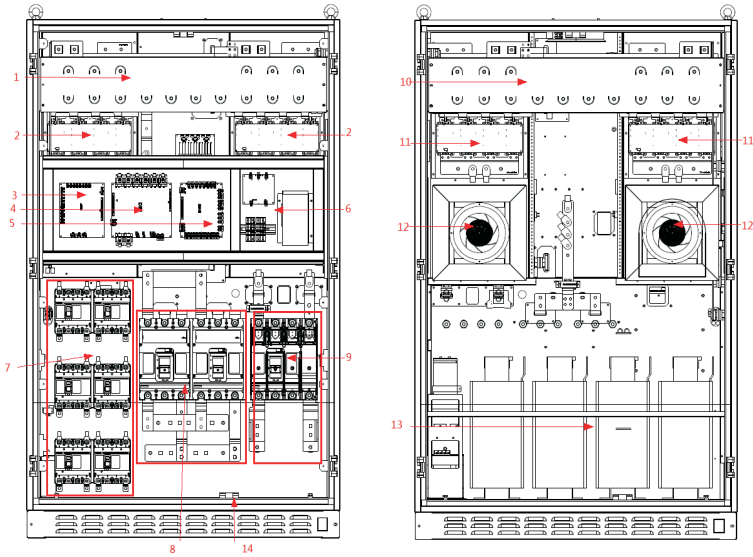

The front structural drawing of PBD350

The back structural drawing of PBD350

Model	PBD350	
NO	Name	Description
1	Capacitance	Filtering and support
2	IGBT module	None
3	Sampling board	Voltage current temperature sampling PCB
4	Control board	Main board includes communication interface
5	Interface board	Power supply conversion PCB
6	Power supply module	Including BUCK board, power source and micro break
7	PV circuit breaker	Control the disconnection of PV with PBD
8	Battery circuit breaker	Control the connection between battery and PBD
9	Output circuit breaker	Control output and the disconnection of PBD
10	Capacitance	Filtering and support
11	IGBT module	None
12	Fan	For cooling the machine
13	Inductance	None
14	Earth terminals	Grounding bronze terminals

3.5 Operation mode define

The following operation mode needs to cooperate with PCS energy storage PBD, and the output terminal of PBD250 / PBD350 should be connected to PCS for use. The mode selection needs to be made on PCS screen. The PBD350 system is equipped with a battery while pbd250 is not. When it charges the battery, the battery on PCS side will be charged first by default under all operating mode, then the PBD battery will be charged secondly; when discharging, the battery with PBD will be discharged first by default.

Please read section 7.2.4 for operation mode setting method.

In the following description of operating mode, PV means the PV end of PBD.

3.5.1 On grid mode

Optional functions in grid connection mode:

Activate anti-reflux function(Select on PCS):

1. When the anti-reflex function is activated, feeding power to utility grid is restricted.
2. When anti-reflex function is disabled, can feed power to utility grid.

Please refer to Section 7.2.4 for setup procedure.

3.5.1.1 Load priority mode (anti-reflux function optional)

1. When PV energy is sufficient, PV supply priority to load, the remaining to battery.
2. When PV power is lower than load power, battery discharge automatically. When the battery voltage gets low to the alarm point, PV and the grid supply power to the load together. To protect the battery, it will use small power energy to charge the battery, and the battery can supply power again after recover.

3.5.1.2 Battery priority mode (anti-reflux function optional)

1. When PV energy is sufficient, PV supply priority to battery charge, the remaining to load;
2. When PV power is lower than the charging power, PV supply priority to battery, the grid supplies to load and battery;
3. If the grid connected backup mode is not discharged or switched to other modes, To maintain electrochemical activity, the battery will enter the discharge state after one week of current limiting charging, and the discharge power will be calculated according to battery specifications.

3.5.1.3 On-grid economic priority mode(anti-reflux function optional)

1. Valley price: working logic is the same to battery priority mode's.
2. Fair price:
 - A. Battery can neither discharge nor be charged by grid.
 - B. PV power supply priority to load, the remaining to battery when PV power is higher than load.
 - C. When PV power is lower than load power, PV and grid supply load, PV doesn't charge battery.
3. Peak price:
 - A. Grid will not charge battery.
 - B. When PV power is higher than load, PV supplies to load, the remaining to battery.
 - C. When PV power is lower than load power, there are two conditions:
 - a. When battery voltage is normal, PV and battery supply to load.
 - b. When the battery is under voltage, battery will not discharge, PV and grid supply to load only, not to battery.

3.5.1.4 Peak shaving mode (anti-reflux function optional)

1. When PV power is sufficient, do not take power from the utility.
2. When PV power is insufficient: (The power taken from the grid shall not exceed the set upper limit)
 1. Take power from the utility to supply load along with PV, the remaining charge battery.
 2. Battery automatically discharge when PV and utility power is not sufficient for load.

3.5.1.5 AC source mode (utility mode)

Under this mode, there is no battery at the output side of PBD and the DC side of PCS. PCS is rectified to the DC side through the power grid and outputs and outputs stable DC voltage, which can be adjusted.

3.5.2 Off-grid mode

1. When PV power is higher than load power, PV supply priority to load power, the remaining to the battery charge.
2. Battery discharge automatically when PV power is lower than load power. when the battery is discharged to the undervoltage alarm point, there are two situations:
 - a) Under default setting, the PBD will stop output and switch to PV charging mode. and there will be no AC output.
 - b) If DG function is enabled, the PBD sends a relay signal to start the DG, and DG supplies the load or charges the battery.

3.5.3 Generator mode

I. Generator access function (dry contact control)

In the off grid mode, when the battery is discharged to the under voltage alarm point, PCS sends a relay signal to start the DG and enter DG mode. The generator will supply power to load; at the same time, PCS stops supplying power to the load and only charges the battery.

1. When PV power is greater than the charging power, PV power is only used to charge the battery; the DG only supplies the load.
2. When PV power is less than the charging power, PV supplies priority to battery; DG supplies power to the load and optionally charges the battery.
3. When the battery is full, PCS sends a signal to stop the DG and switch to off grid mode.
4. When completely off grid, DG can be directly connected to PCS grid terminal; in the case of utility and DG both exist, it needs to be used with an ATS.

3.5.4 PV mode

1. When utility is unavailable, turn on the knob without clicking the LCD power-on key, PCS will start to enter PV mode, then PV only charges the battery and will not invert AC output.
2. When utility is unavailable, manually start the LCD screen in PV mode, then PCS enters off grid mode.
3. In the off grid mode when discharged to the battery low voltage alarm point, PCS will stop DC/AC converting and automatically switch to PV mode. When battery is charged to the set voltage, it automatically switches to off grid mode.
4. When the power grid returns normal, PCS automatically switch to grid tie mode.

3.5.5 Automatic on/off grid switch

Operate logic: when the utility is normal, the system automatically connect to grid and disconnect when utility turns abnormal.

3.5.6 Fault mode

When PBD fails, the contactor on AC and DC sides will immediately disconnect and shut down PBD, so as to ensure the system safety. At this time, PBD will continuously monitor whether the fault is eliminated, If not, it will maintain the fault state; after eliminated, it will restart automatically.

3.5.7 Permanent failure mode

When PBD has a serious fault, the contactor on AC and DC sides will immediately disconnect and enter a permanent fault state to ensure safety of the system. When permanent fault is detected three times in a row, all switches will be disconnected. For example, the energy storage controller module of PBD is faulty. When PBD enters this permanent failure mode, please do not repair it without permission. You should contact the personnel of the local dealer or call Shenzhen Ates Power Technology Co., Ltd. for help.



When temperature gets too high, output power of PBD will decrease, which is normal. However, if this happens frequently, check the cooling surface of PBD or place it in a place with good ventilation condition. If the fan gets dirty, please clean the dust on it. If there is any problem inside the PBD, please contact the professional service department for help.

3.6 Instructions for using load

Now PBD series have to be applied with PCS energy storage PBD. PBD only outputs DC, and the output terminal needs to be connected with battery for voltage stabilization to work normally. Please keep in mind that PBD output terminal cannot operate without battery.

Model	PBD250	PBD350
Rated power(kw)	250	350
DC load(kw)	250	350

If the DC load power is greater than the rated output power of the selected model, it is recommended to use multiple PBDs for parallel operation.

3.7 Dimension and weight

Model	PBD250	PBD350
Dimension (W*H*Dmm)	850X1900X700mm	1200X1905X850mm
Weight(net/gross)(kg)	300/350	600/650

Figure—Demension and weight of PBD

3.7 Packing information

NO	Name	Unit	Qty.	Note
1	PBD	unit	1	Key included
2	User manual	pcs	1	
3	Certificate	pcs	1	
4	Factory test report	pcs	1	

Figure—Packing information

4 Transportation and storage

4.1 Transportation

Transportation should follow the transportation methods described in the user manual. The PBD's weight and center of gravity should be taken into account during transportation. The center of gravity is marked on the box.



Caution, risk of danger

During transportation, lifting equipment and personnel must be qualified. The PBD should be placed vertically and the inclination cannot be more than 10 degrees. It is not allowed to place the PBD upside down or transport in a horizontal position. Incorrect lifting and transportation can lead to serious injury, property loss and damage to the controller.

4.2 Inspection and storage

The PBD should be carefully checked before signing the document from the transportation company. Check the received items against delivery note, and if there is any defect or damage, immediately notify the transportation company. If necessary, you can seek help from Atecs Customer Service department.



Caution

ATESS PBD can only be stored when it is sealed. Therefore make sure it's dust and moisture-proof inside the machine. If storage time is long, PBD must be stored in a dry environment to prevent water from entering inside.

5.1 Installation condition requirements

To ensure normal operation of the machine, the installation environment is required as follows:

- > The ingress protection of PBD is IP20. Moreover, as this product is an electronic equipment, it shall not be placed in humid environment;
- > Install indoors and avoid sunlight and rain;
- > Ventilation of the room shall be good;
- > The installation environment shall be clean;
- > As some noise will be produced in operation, this equipment shall be installed far from residential quarters;
- > The installation ground shall be even enough, and firm enough to support the weight of PBD;
- > The installation position shall be convenient for maintenance;
- > Ambient temperature range: -25°C ~ 55°C ;
- > Appropriate space shall be reserved for the machine to ensure ventilation and cooling.

We suggest PBD to be installed in the distribution room. The floor, wall clearance, Ventilation equipment and precaution should be designed by professional personnel and satisfy the following requirements.

> Foundation requirement

PBD is required to install on even ground with fire-retardant material as the surface or channel steel support structure, and sag or tilt ground is prohibited. The foundation shall be solid, safe and reliable. The foundation shall be capable of bearing the load of PBD. Its load bearing ability shall be concerned throughout the installation place selection.

> Clearance space

During installation of the PBD, appropriate space shall be left to the wall or other equipment, in order to satisfy the requirements on narrowest maintenance channel, emergency access and ventilation.

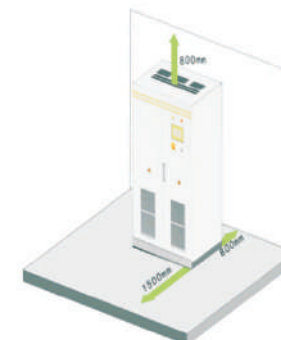

In front of the installation place of PBD, a space of 1.5m or more shall be ensured, the back 0.8m or more, the top 0.8m or more to ensure easy installation, cooling and maintenance.

> Cable trench

The cable connection of PBD adopts bottom inlet and bottom outlet. Cable trenches are recommended to ensure easy installation and maintenance.

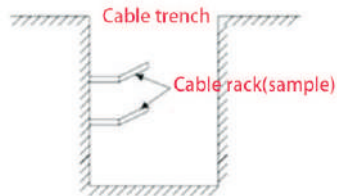

The cable trenches are often designed and constructed by the construction side based on relevant standards, with the equipment weight and dimensions required to be considered. Good electrical connection is needed between different cable trenches and GND terminals.

> Wiring specification

Cables in the PBD can be classified into either power cables or communication cables. In cabling, the power cable shall be kept far away from, and the cable shall be kept in right angle at cross. The cable shall be as short as possible, and an appropriate distance shall be kept to the power cable. The insulation impedance of Bt + and Bt - at DC end to ground is recommended to be greater than 1 Ω .

The power cable and data access shall be placed in different cable trenches respectively to avoid lengthy routing between the power cable and other cables, so as to reduce the electromagnetic interruption caused by sudden change of the output voltage. The distance among the power cable and data access shall be more than 0.2m. When the cables are crossed, the cross angle shall be 90 degrees, while the distance can be reduced appropriately.

> Ventilation requirement

In operation, PBD will produce a lot of heat. When ambient temperature is too high, the electrical property of the equipment may be affected, the equipment may even be damaged. Therefore, the heat release shall be fully considered in designing the control room to ensure operation of the equipment in high efficiency.

> Ventilation environment

To satisfy the ventilation requirement of PBD, its installation environment shall meet the following conditions:

- ※ PBD shall be prevented from being installed in the place of poor ventilation condition and insufficient air flow;
- ※ The air inlet shall have enough air supplementation.

> Ventilation equipment

To ensure safe and reliable operation of the equipment, the ambient temperature must be within the permission range $-25^{\circ}\text{C} \sim 55^{\circ}\text{C}$, therefore, appropriate ventilation devices must be equipped with to release the heat generated by the equipment. We suggest the ventilation rate be more than $3665\text{m}^3/\text{h}$.

1. There must be ventilation equipment inside the distribution room to ensure release of the waste heat generated by the PBD from the equipment, and allow for maximum ambient environment temperature. This can be realized from installation of exhaust devices;
2. Another fan can be added at the air duct outlet to exhaust the air out and ensure balanced pressure;
3. The direction of the air outlet shall be selected according to the local actual wind direction;
4. Pay attention to the dustproof measures and waterproof design at the air inlet and outlet;
5. If more air ducts are required, its dimensions shall be designed by the professionals according to the air output amount.

> Other protections

With IP20 of protection level, PBD is appropriate to be installed in dry and clean environment. Meanwhile, water leakage of the house shall be prevented, as it may damage the PBD. According to EMC requirement and noise level, the PBD shall be installed in industrial environment.

5.2 Tools and spare parts required for whole machine installation

Tools and spare parts required for installation is as follows:

- > Hoisting crane, forklift or fork lift truck (with the capacity for bearing the weight of the PBD)
- > Torque wrench
- > Screwdriver
- > Wire stripper
- > Terminal crimping machine
- > Heat dryer
- > Megger and multimeter

5.3 Mechanical installation

5.3.1 Transportation of packaged whole machine

This PBD is transported as an integrated unit, and the user can hoist it from the bottom with a forklift, or move it with a hoisting crane or crane.

Note 1: The PBD is integrated and cannot be dissembled either in transportation or installation. Any fault attributed to modification unauthorized by ATESS is beyond our warranty liability.

Note 2: In movement, tilt, violent shake or sudden force upon the PBD shall be prevented, such as sudden down or lifting.





Note 3: Please read carefully the labeled parameters to select an appropriate transportation means and storage place.

We suggest the user make use of forklift to move the PBD if possible.



Before the PBD is moved to the designated place, we suggest to lay the DC input cable and AC main power supply cable. As these cables are relatively thick, they are hard to be cabled after the PBD is installed.

To keep the equipment in a better protective status, please adopt transportation with package as much as possible, and comply with the labels printed on the package in transportation:

Sign	Indication
	The gravity centre
	Lifting logo
	Face up to prohibit the PBD horizontally, tilted or upside down
	Handle with care, to avoid the transport environment too intense collision friction damage to the PBD
	Keep away from moisture

PBDs whose packages are not demolished can be moved with forklift, hoisting crane or crane. In moving, attention shall be paid to the weight painted on the package to ensure enough load capacity of the devices. As the gravity center of the equipment locates at the lower place symmetrical in front and back and left and right, the support point or hoisting point shall be arranged reasonably in transportation.

The forklift transportation is the standard one. The gravity center of the cabinet in transportation should locate between two forks of the forklift. The big-size PBD may block driver's sight, and it shall be treated with cooperation of the aid personnel.

5.3.2 Movement and installation of bare machine

> Demolish the package of PBD

Please demolish the packaged cabinet of the equipment according to the following procedures:

Procedure 1: Demolish the wood side and roof of the packaged cabinet

Procedure 2: Demolish the out-set package material on the machine

Procedure 3: Demolish the fastening screws between the machine and the pallet

- ① Demolish the front and back cover lids of the pedestal;
- ② Screw off the hold-down nuts at the bottom of the wood pallet;
- ③ Remove the screws, and the PBD will depart from the wood pallet.

> Movement and installation of bare machine

The PBD with demolished package can be moved with forklift, hoisting crane, slide rail or crane. If the package demolished place is far from the final installation place, it can be transported with forklift containing wood pallet.

If the wooden pallet at the bottom of the machine has been removed, when using the forklift, the front and rear cover plates of the base need to be removed first, and the center of gravity should be placed in the middle of the two forklifts, and then start lifting and transporting, as shown in the following figure:



Caution, risk of danger

We must act slowly and gently when transporting the PBD with forklift to avoid violent vibration of the PBD or collision with other objects.

If lifting method is used for moving, please pay attention to the lifting position, ensure that the lifting angle is 70°, and be cautious of the center of gravity position of the PBD.

NOTE:

- > It is necessary to always pay attention to the position of the center of gravity of PBD.
- > Take necessary auxiliary measures to ensure the safety of transportation personnel;
- > Take necessary auxiliary measures to ensure that the equipment is delivered to the final installation site.

5.4 Electrical installation

5.4.1 Input and output requirements



Caution, risk of danger

> There is a danger of electrical shock of high voltage in PBD's operation; only electricians of professional skills can operate.

> All connections with this equipment shall be done under non-voltage state.

> The PBD may be damaged if input or output terminal is incorrectly plugged.

Failure of acting upon this information may cause serious personnel injury or significant property loss even to death.

> Battery

The positive and negative highest voltage of the battery for PBD350 shall not exceed 800V, for PBD250 shall not exceed 850V, otherwise, the equipment will be in over-voltage protection state, and cannot work normally.

> Cable requirements

Model	PBD250	PBD350
PV	Cable Diameter per string: 35mm ²	Cable Diameter per string: 35mm ²
Battery	Cable Diameter: 2*120mm ²	Cable Diameter per string: 300mm ²
Output	Cable Diameter: 2*120mm ²	Cable Diameter per string: 300mm ²
Earth wire	16mm ²	16mm ²
Communication wire	Shielded wire: 0.75mm ²	Shielded wire: 0.75mm ²

5.4.2 DC side wiring

Caution, risk of danger



The PBD only has DC input and output, the positive and negative of it shall not be connected in reverse. A multimeter shall be used to determine the polarity first, and then connect into the corresponding input ends of the PBD. Fans of all internal modules in PBD250 get power supply from PV1. If there are less than 5 strings of PV modules connected, it has to be connected to PV1.

Specific procedures are as follows:

- 1) Cut off the distribution circuit breaker at the DC side, and ensure that no voltage on the wire at DC side.
- 2) Use a multimeter to measure the open circuit voltage of the battery to ensure that it is within the allowed range.
- 3) Determine the positive and negative pole of the battery with a multimeter.
- 4) Strip off the insulation skin at the end of the cable
- 5) Crimp the wiring copper nose.
 1. Put the stripped copper core into the crimping hole of the copper nose.
 2. Use the terminal pressing machine to press the copper nose tightly. The number of crimping shall be more than two.
- 6) install the heat-shrinkable sleeve.
 1. Select heat-shrinkable sleeve which is consistent with the cable size, length is about 5cm.
 2. The heat-shrinkable sleeve shall be sleeved on the copper nose of the wiring to completely cover the wire pressing hole of the copper nose.
 3. Use a heat blower to tighten the heat-shrinkable sleeve.
- 7) Connect "Battery-input +" of PBD to the positive pole of battery.
 1. Select the bolts that match the copper nose.
 2. Connect the copper nose at both ends of the wiring firmly to the "battery input + (BAT+)" end of PBD and the positive pole of the battery.
 3. Tighten the bolts with a screwdriver or wrench.
- 8) Connect the "battery input - (BAT-)" end of PBD to the negative pole of the battery by cable according to the method of step 7.

- 9) cable the "PV input +" end of PBD to the positive pole of the PV module according to step 7.
- 10) cable the "PV input -" end of PBD to the negative pole of the PV module according to step 7.
- 11) Please be sure that all wirings are fastened.

5.4.3 Earthing

For safety, all PBDs need to be grounded through PE conductors. Make sure the PE copper bar in the PBD cabinet has been reliably connected with the shell of PBD, and when doing PE connection, the PE grounding copper bar needs to be reliably connected with the equipotential connection device in the installation site or electrical control room. And make sure the earthing cable is more than half of the load cable, and earthing resistance is not lower than 4Ω.

All the wiring inlet and outlet is placed at the bottom of PBD. When all the wiring is completed, the connection port must be sealed with dust cotton, to prevent dust or animal from entering the PBD.



Connect several connecting wires on the PE copper bar as some parts inside the energy storage controller need to be grounded, please do not change them without permission, so as to avoid electric shock

5.4.4 Fan power wiring

The top fan of PBD250 needs AC-220v for power supply, and AC-220 needs to be connected to the position of the relay below. After the connection is completed, the relay switch needs to be turned on.

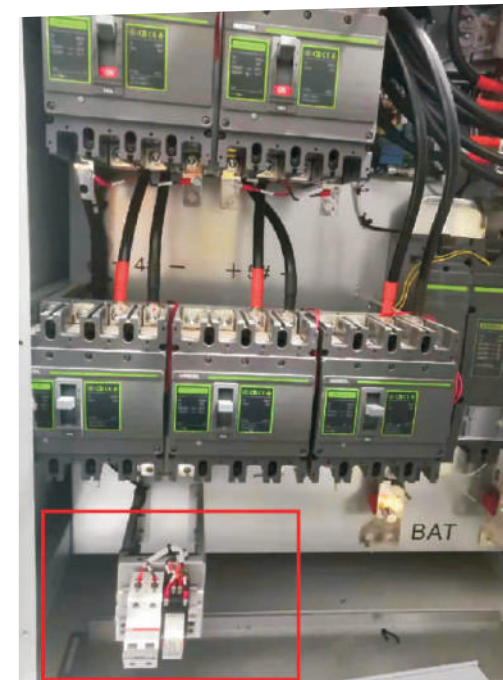

5.5 Communication

The ATESS PBD controller adopts a variety of communication modes.

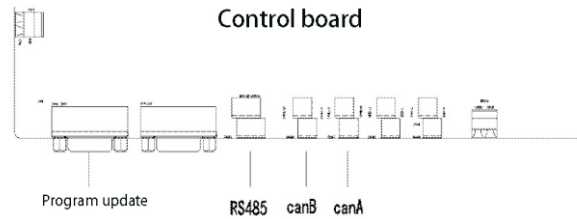

1. Host computer RS485 communication

PBD communicates with each other through RS485 line, and finally connects to our Shinemaster, which uploads the PBD data to the server through network. It can remotely and real-time monitor the operation status of single / multiple PBD(s). Terminal blocks are used at both ends of RS485 communication line, by paralleling the two blocks it will make RS485 line, which shall not exceed 1000m. In order to ensure transmission quality, special twisted pair shielded communication line shall be applied. The 485 interface is located in the internal control board CN16 of the machine.

If Shinemaster is not used for monitoring, the user's own monitoring equipment needs to be compatible with 485 communication protocol of ATESS.

2. CAN communication

- CAN communication is required when PBD is equipped with battery with BMS. Connect CAN A of PBD to the CAN port of battery, and communication can be realized after docking the communication protocol.
- The PBD needs to communicate with ATS when applied together, and CAN B of PBD shall be connected to the can port of bypass cabinet.
- Terminal blocks are used at both ends of communication line, by paralleling the two blocks it will make a CAN line. Special shielded communication line is recommended, which is provided by ATESS.
- The CAN A interface is located in the internal control panel CN17, which is a special CAN communication interface for BMS.
- The CAN B interface is located in the internal control panel CN18, which is a special communication interface for PCS.

3. Parallel communication (special for customized parallel function)

- Parallel communication is required when multiple PBD models are used in parallel.
- CAN A communication is adopted for parallel communication, and hand-held connection through CAN A between PBDs is required to realize mutual communication.



As Parallel function is a special customized function, users cannot parallel the models on their own.

5.6 Wiring single/parallel system and CAN communication

5.6.1 Single unit wiring

The following is the system wiring diagram of single PBD with PCS:

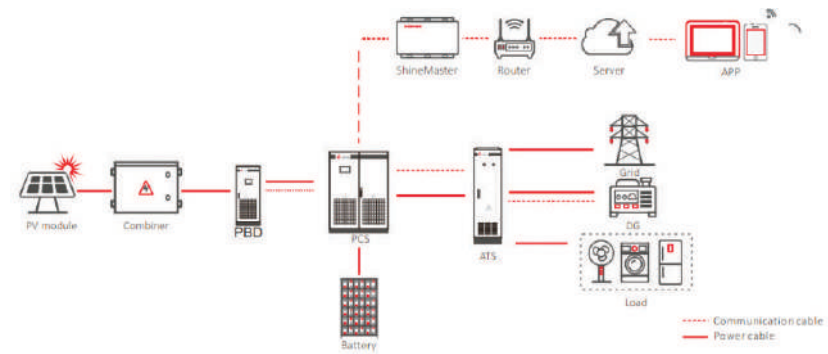

The following is the system CAN communication wiring diagram of single PBD connected to PCS. PBD250 does not include battery, and the CAN-A on its control board does not need to be wired. While PBD350 includes a battery pack, thus the CAN-A on PBD control board needs to be wired to the battery CAN port. The CAN wiring of the stand-alone system is as follows:

Note: the wiring marked on the manual is for normal use. If the actual wiring is adjusted, the wiring provided by professionals shall prevail.

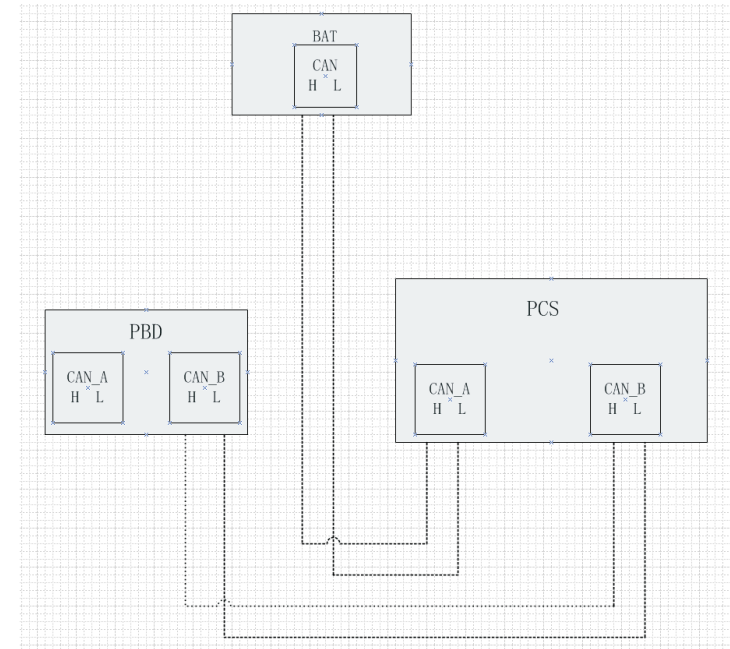

5.6.2 Wiring of parallel system and CAN communication

The system wiring diagram of 4 parallel PBDs with 2 PCS is listed below. The output terminals of multiple PBDs are connected together and then connected to the battery terminal of PCS.

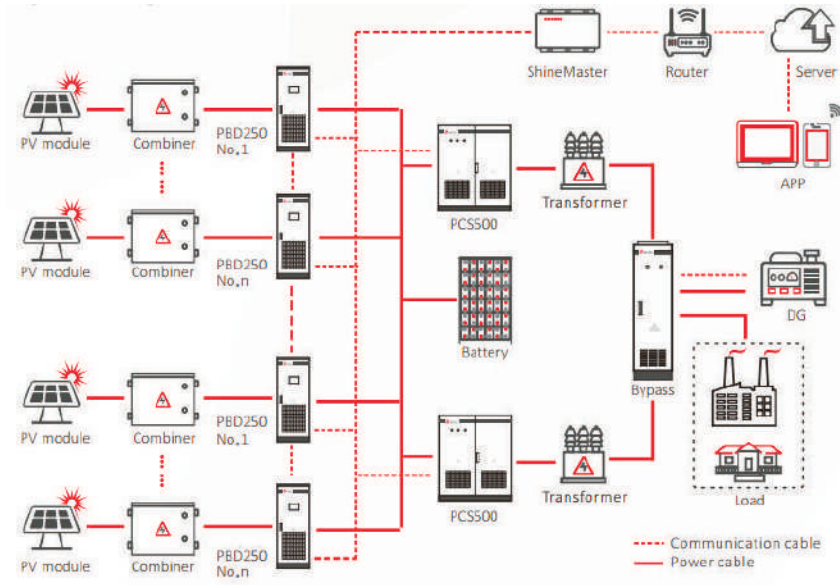

The following figure is the wiring diagram between the CAN communication of the above system, including the connection mode and port of CAN communication when multiple PBDs are parallel. If there are only one or multiple PBDs, the CAN connection port remains the same and the port connected to the PCs remains the same.

Note: the wiring marked on the manual is for normal use. If the actual wiring needs to be adjusted, the wiring provided by professionals shall prevail.

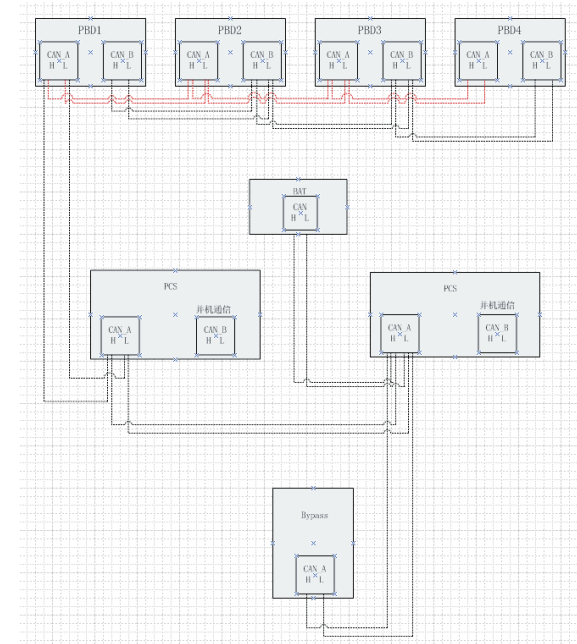

Commissioning 6

6.1 Inspection before operation

Before the PBD is put into operation, its installation shall be inspected. At least two staff do the inspection according to the items listed below to ensure the correctness of the installation.

Inspection items for installation

- There is no deformation or damage to PBD.
- Bottom of the PBD is fixed securely, the foundation support is stable and reliable.
- There is enough space around the PBD.
- The temperature, humidity and ventilation conditions of the environment where the PBD is located meet the requirements.
- There is enough cooling air for ventilation.
- Cabinet sealing protection is complete and reliable

Electrical inspection

- PBD is grounded completely and firmly.
- The grid voltage matches the rated output voltage of the PBD.
- The phase sequence of grid connection is correct, and the tightening torque meets the requirements.
- The positive and negative poles of DC input connection are correct, and the tightening torque meets the requirements.
- Communication wiring shall be correct and keep a certain distance from other cables.
- Cable number is marked correctly and clearly.
- The insulation protection cover is complete and reliable, and the danger warning label is clear and firm.

Other inspection

- All useless conductive parts shall be tied with insulating ties.
- There are no tools, parts, conductive dust or other foreign matters left inside the cabinet.
- There is no condensation of moisture or ice in the cabinet.

6.2 Power on steps

PBD adopts DC power supply method.

➤ Battery power supply

The battery can be used for the first time power-on. When the battery breaker is closed, the LCD should be on.

After power on, please do not switch the power-on knob immediately. Please check the fault information page and check whether the operation setting is in line with the actual situation. Please refer to Chapter 7 for details.

7 GUI instruction

7.1 LCD display screen introduction

User can view the information of the PBD operation on the LCD touch screen, as well as setting the operating parameters. In order to facilitate the operation, a menu is provided below.

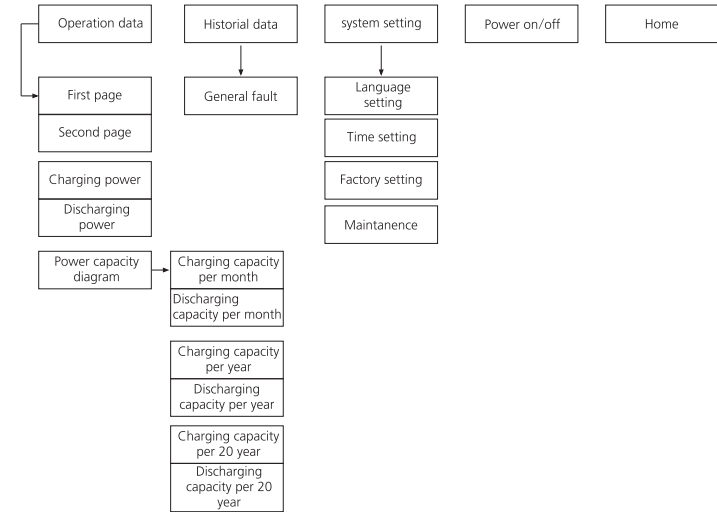

PBD LCD Menu logical structure

After powering on the LCD, it will enter the home page after about 15s. Then you can begin to read the information and set the parameters.

Communication state of PBD and LCD (✓ means normal and × means communication fault), station number and system time is displayed at the right top of each page of the LCD.

Each page has five commonly used function keys: "run data" "historical information" "system settings" "Power on/off" "Home" at the below of the page. Through these keys users can easily operate. On the left of the page it shows the corresponding sub-menu of the five keys, and it will be marked green after selected.

7.2 LCD operation

7.2.1 Home page

When powered or clicking "Home" button in any interface will enter into the Home page.

The operating status of the PBD, input and output voltage, current information etc. can be viewed in the page. Pressing the following key can switch to other pages.



7.2.2 ON/OFF interface

Clicking "ON/OFF" button in any interface will enter into this interface.

There are "ON" and "OFF" button which is used to turn on and turn off the PBD.

Start up: turn the start knob to on and click "on" to start up successfully.

Shut down: shut down by clicking "off", or turn the start / stop knob to off directly.

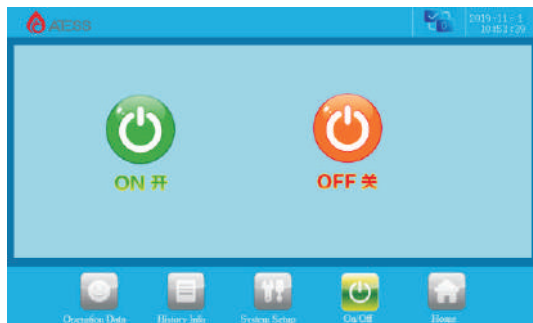

7.2.3 Operation data

Click [operation data] at the bottom of any other interface to enter the submenu of "operation data".

The submenu includes: operation data, power curve, charge and discharge capacity. The corresponding submenu interface can be accessed through the left button. The default one is "operation data" interface.

A number of data under the interface are inserted through the "USB" interface on the back of the LCD screen. The real-time running data of the PBD will be automatically stored in the USB every other minute. The PBD will automatically create a DTL file in the USB every month for data storage, which can be transferred to Excel file and through which can view the historical record information.

Operation data: display the current parameters and real-time data of energy storage power generation, including grid voltage, grid frequency, grid current, DC input voltage, DC input current, temperature in the case and total generation time (real-time update).



7.2.4 System setting

Clicking "System setting" button in any interface will enter into this interface.

Submenu: language settings, time settings, PBD information, maintenance. Pressing the left button can enter into the corresponding submenu interface. The default one is language setting interface.

➤ Language Settings: Select language, currently it only supports Chinese, English.



➤ Time settings: system time setting (if the date and time displayed on LCD is not inconsistent with the actual date and time, they can be modified here).



➤ **Device Information:** This page shows the manufacturer, PBD serial number, hardware and software version information, and the date of manufacturing, data in this page cannot be changed.



➤ **Maintenance:** the interface requires a password to login. It is for electrician and maintenance personnel who are fully familiar with the structure and working principle of the system only, in order to avoid damage to personal safety and the PBD, and please operate carefully.

- Enter the correct password to enter the submenu of "equipment maintenance". The submenu includes: protection parameters, calibration parameters, power grid management, factory settings. The default one is "protection parameters".

1. Protection parameters:

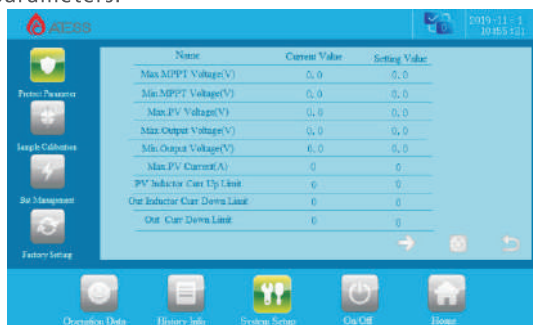

➤ This page is set for the protection parameters of the machine. These parameters will be set when the machine leaves the factory. It can only be changed after confirming with the professional personnel.

Upper and lower limits of MPPT voltage: the selection range of PV voltage. The maximum open circuit voltage of PV shall be less than the upper limit value, if the PV voltage is less than the lower limit value, PV output will be stopped, and the PV panel shall be configured reasonably.

PV voltage upper limit: if the PV voltage is higher than the set value, the machine will report PV overvoltage fault and cannot operate.

Upper and lower limit of output voltage: if the output voltage is higher than the upper limit or lower than the lower limit, a fault will be reported and the operation will be stopped.

PV current upper limit, PV inductance current upper limit, output inductance current upper limit, output current upper limit: when the current exceeds the set value, the corresponding fault information will be reported, and the machine will stop running.

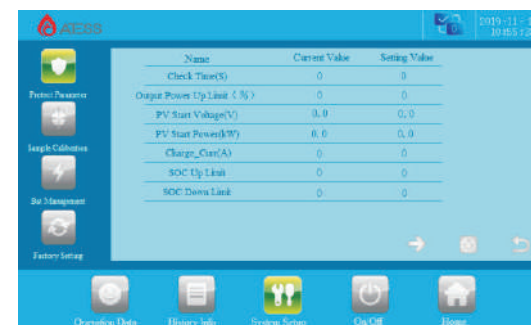

➤ This page is set for the protection parameters of the machine. These parameters will be set when the machine leaves the factory. It can only be changed after confirming with the professional personnel.

Detection time: when the machine is started up, it takes some time to detect. This time is used to determine whether the machine is soft started successfully. Later on, the contactor is closed, the machine is started successfully and enters normal working state.

Upper limit of output power: the upper limit value of the output power of the machine, which is set by percentage. The maximum output power is the set upper limit value.

PV starting voltage: the minimum voltage to be traced by MPPT.

PV starting power: if PV power is less than this power, restart MPPT for tracking.

Battery charging current: When charging normally, the charging current will reach this setting value.

SOC upper and lower limit: when the charge reaches SOC upper limit, the battery stops charging; when the discharge reaches SOC lower limit, the battery stops discharging. (when SOC judgment is needed, it shall be indicated on the technical agreement)

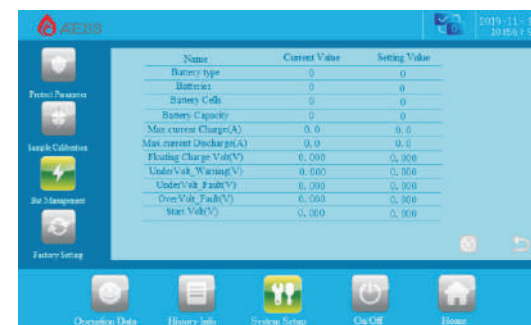

This page will be set according to the technical agreement before delivery

➤ This page is the battery parameter setting page. As battery is an important part of the energy storage system, the battery parameters need to be carefully confirmed whether they are consistent with the actual situation.

Battery saturation: reduce the charging current in advance to prevent overcharge. If it is set to 2, the charging current will be reduced when the floating charging voltage is - 0.2V.

Number of batteries: the number of battery in parallel. E.g. 2V / 200ah battery, 240 in series and 2 in parallel, the number of groups should be 2.

Number of battery cells: the number of batteries in each string. E.g. 2V / 200ah battery, 240 in series and 2 in parallel, the number in each string should be 240.

Battery capacity: single unit battery capacity, unit: ah. If 2V / 200ah, 240 in series and 2 in parallel, the capacity is 200ah.

Battery charging overcurrent protection: the maximum value of the total charging current of the battery. HPS will protect if the actual charging current is greater than the protection value.

Battery discharge overcurrent protection: the maximum value of the total discharge current of the battery. HPS will protect when the actual discharge current is greater than the protection value.

Floating charge voltage setting: the floating charge cell voltage value of the battery. When the cell voltage reaches this set value, the charging current approaches 0A.

Battery undervoltage alarm: the cell voltage value when battery undervoltage alarm activates. When the battery cell voltage reaches the undervoltage alarm point, it will stop discharging and switch to trickle charging in grid connected state. Different processing will be made according to different modes in off grid state. Please refer to "operation mode - off grid mode" in Chapter 3.5.

Battery undervoltage protection: the cell voltage value of battery undervoltage protection. When the battery voltage reaches this set value due to discharge, HPS will stop for protection.

Battery over-voltage protection: the over-voltage cell voltage value of the battery. When the battery voltage reaches this set value, HPS will protect and shut down.

Battery start voltage: Only when the HPS battery cell voltage gets higher than the start voltage, HPS can start.

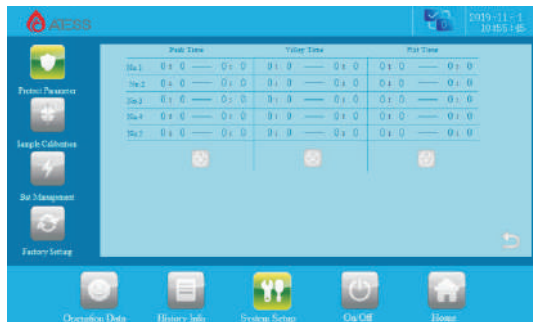

This page will be set according to the technical agreement before delivery

This page is the economic mode time period setting page, which only takes effect in economic mode. The time period after 24 o'clock must be divided into two settings. For example, 20:00-6:00 is the valley period, which needs to be set as 20:00-00:00, 00:00-6:00.



The page without instructions is factory preset parameter, please do not modify.

If the subsequent scheme changes, please modify the parameters under the guidance of ATESS.

2. Calibration parameters:



➤ This page is the calibration value of sampling coefficient. If the sampling is not accurate, it can be calibrated through this value. It is strictly forbidden for customers to calibrate this coefficient. If the sampling is not accurate, it needs to contact professional personnel to operate.

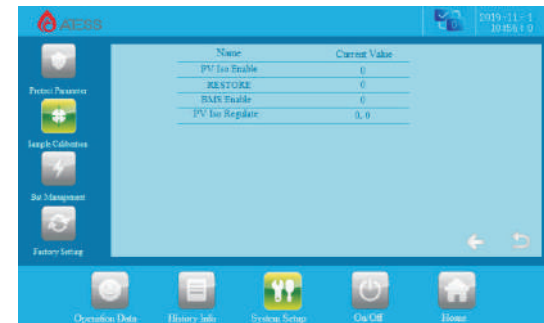

➤ Allowed modification points: "BMS communication enable", The enabling model: PBD350, this requires the battery has a battery energy management system. When the battery is with BMS communication, please set to 1; otherwise, set to 0.

3. Factory settings



The value on this page are important factory preset parameters. Please do not modify them without the consent of ATESS.

i The page without instructions is the factory preset parameter, please do not modify. If the subsequent scheme changes, please modify the parameters under the guidance of ATESS.

7.2.5 Historical information

Clicking "historical information" can enter into the sub-menu of the "historical information".

The submenu includes: Common historical failure, serious historical failure. Via the left button you can enter the corresponding submenu interface. The "common historical faults" is the default interface.

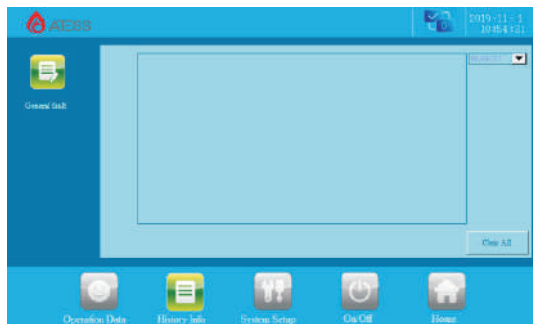

History of failure: all the common history of failure details can be found by flipping the page up and down, and you can empty the table by deleting it.

Regarding more info for the common fault information, see table 7.3.

7.3 LCD display information schedule

General history failure table

1	PV_Inverse_Failure	Pv接反永久故障
2	IGBT_Failure	IGBT永久故障
3	EEPROM_Write_Failure	EEPROM写永久故障
4	EEPROM_Read_Failure	EEPROM读永久故障
5	MainContactor_Failure	主接触器永久故障
6	SlaveContactor_Failure	辅接触器永久故障
7	RISO_Failure	绝缘阻抗永久故障
8	PV1_VoltHigh_Fault	PV1过压故障
9	PV2_VoltHigh_Fault	PV2过压故障
10	PV1_CurrHigh_Fault	PV1过流故障
11	PV2_CurrHigh_Fault	PV2过流故障
12	BAT_OverVolt_Fault	电池过压故障
13	BAT_UnderVolt_Fault	电池欠压故障
14	BAT_OverCurr_Fault	电池放电过流故障
15	BAT_OverCharge_Fault	电池充电过流故障
16	OUT_OverVolt_Fault	输出过压故障
17	OUT_OverCurr_Fault	输出过流故障
18	PV_L1_BuckOverCurr_Fault	PV电感1过流故障
19	PV_L2_BuckOverCurr_Fault	PV电感2过流故障
20	OUT_L1_BuckOverCurr_Fault	输出电感1过流故障
21	OUT_L2_BuckOverCurr_Fault	输出电感2过流故障
22	BMS_Communication_Fault	BMS通讯故障
23	BMS_Fault	BMS故障
24	PV_L1_BuckOverCurr_Fault(INT)	PV电感1过流故障(INT)
25	PV_L2_BuckOverCurr_Fault(INT)	PV电感2过流故障(INT)
26	OUT_L1_BuckOverCurr_Fault(INT)	输出电感1过流故障(INT)
27	OUT_L2_BuckOverCurr_Fault(INT)	输出电感2过流故障(INT)
28	PV1_OverVolt_Fault(INT)	PV1过压故障(INT)
29	PV2_OverVolt_Fault(INT)	PV2过压故障(INT)
30	BAT_OverVolt_Fault(INT)	电池过压故障(INT)
31	OUT_OverVolt_Fault(INT)	输出过压故障(INT)
32	BUS_OverVolt_Fault(INT)	母线过压故障(INT)
33	PV1_OverCurr_Fault(INT)	PV1过流故障(INT)
34	PV2_OverCurr_Fault(INT)	PV2过流故障(INT)
35	BAT_OverCurr_Fault(INT)	电池过流故障(INT)

36	OUT_OverCurr_Fault(INT)	输出过流故障(INT)
37	PV_L3_OverCurr_Fault(INT)	PV电感3过流故障(INT)
38	PV_L4_OverCurr_Fault(INT)	PV电感4过流故障(INT)
39	PV_L5_OverCurr_Fault(INT)	PV电感5过流故障(INT)
40	OUT1_OCP_Fault	输出电感1过流故障 (Trip)
41	OUT2_OCP_Fault	输出电感2过流故障 (Trip)
42	PV1_BuckOCP_Fault	PV电感1过流故障 (Trip)
43	PV2_BuckOCP_Fault	PV电感2过流故障 (Trip)
44	DC1_Thunder_Fault	直流1防雷器故障
45	DC2_Thunder_Fault	直流2防雷器故障
46	BAT_SoftStart_Fault	电池软启故障
47	OUT_SoftStart_Fault	输出软启故障
48	PV_Module_OverTemp_Fault	Pv模块过温故障
49	OUT_Module_OverTemp_Fault	输出模块过温故障
50	PV_Inductor_OverTemp_Fault	Pv电感过温故障
51	OUT_Inductor2_OverTemp_Fault	输出电感过温故障
52	LowTemp_Fault	低温故障
53	BUS_Insulation_Fault	母线对地绝缘阻抗故障
54	PV_IGBT_Fault	PV_IGBT故障
55	OUT_IGBT_Fault	OUT_IGBT故障
56	EPO_Stop	紧急停机
57	KeyEmergencyStop	手动关机
58	LcdEmergencyStop	LCD关机
59	BAT_MainContactor1_Fault	电池主接触器故障
60	OUT_MainContactor2_Fault	输出主接触器故障
61	BAT_SlaveContactor_Fault	电池辅接触器故障
62	OUT_SlaveContactor_Fault	输出辅接触器故障
63	PV_Module_OverTemp_Fault	Pv模块过温故障
64	Fault_Feedback_Warning	脱扣告警
65	Temp_Derating_Warning	过温减载告警
66	BAT_UnderVolt_Warning	电池欠压告警
67	PCS_Communication_Warning	PCS通信警告
68	PV3_VoltHigh_Fault	Pv3过压故障
69	PV4_VoltHigh_Fault	PV4过压故障
70	PV5_VoltHigh_Fault	PV5过压故障
71	PV3_CurrHigh_Fault	PV3过流故障
72	PV4_CurrHigh_Fault	PV4过流故障
73	PV5_CurrHigh_Fault	PV5过流故障
74	PV_L3_OverCurr_Fault	PV电感3过流故障
75	PV_L4_OverCurr_Fault	PV电感4过流故障

76	PV_L5_OverCurr_Fault	PV电感5过流故障
77	PV3_OverVolt_Fault(INT)	PV3过压故障(INT)
78	PV4_OverVolt_Fault(INT)	PV4过压故障(INT)
79	PV5_OverVolt_Fault(INT)	PV5过压故障(INT)
80	PV3_OverCurr_Fault(INT)	PV3过流故障(INT)
81	PV4_OverCurr_Fault(INT)	PV4过流故障(INT)
82	PV5_OverCurr_Fault(INT)	PV5过流故障(INT)
83	DC3_Thunder_Fault	直流3防雷器故障
84	DC4_Thunder_Fault	直流4防雷器故障
85	DC5_Thunder_Fault	直流5防雷器故障

7.3.1 troubleshooting methods and steps

The troubleshooting steps are as follows:

1. Observe the screen fault record information.
2. Observe whether the operation data on the screen is abnormal.
3. If the operation data display is normal, try to restart. See whether the machine can be restarted. If it can, the fault has been eliminated. If the operation data display is abnormal, see if there is a method to measure the actual value, and then contact the professional for assistance.
4. If you try step 3 but fails to restart, power on the machine again, and then restart it again.
5. If the machine cannot be restarted, it means that the fault cannot be eliminated automatically, and professionals need to be contacted.

Note: in case of machine failure, the user is required to record the working condition of the machine clearly, such as: the machine is running in grid tied condition or off-grid, how much load it is running with, etc.; this is convenient for troubleshooting; if the machine has serious failure, such as the circuit breaker jumping off, please contact the professional personnel, and do not restart the machine.

8 Operation

8.1 Power on steps

After installation and system settings are inspected, inverter can be started for operation.

> First run

The first operation steps are as follows:

1. Turn on the PBD_pv, battery, output and power supply micro disconnect switch.
2. Check whether the screen sampling data is normal and consistent with the actual situation;
3. After checking, turn the knob to "on", click "start" on the LCD "power on/off" page, and wait for the machine to enter "operation mode";
4. During operation, observe whether the data displayed on the screen is normal, whether there is fault information reported, and whether the machine has abnormal noise and peculiar smell; if there is any abnormal situation, please stop the machine immediately for inspection.



Warning!

During inspection, please make sure that there is no power supply for the machine. Please pay attention to safety.

Manual shutdown

During operation, click the shutdown button on the LCD, or directly turn the knob to "off" to stop the inverter.



Warning!

1. After clicking the LCD shutdown button to shut down the machine manually, it must be turned on manually through the start button (on) on the LCD; if the machine is turned off by turning the knob to "off", turn the PBD knob to "on" first, and then click the "on" button on the LCD "switch on" page to start the machine, otherwise PBD cannot start automatically.
2. The PBD is still electrified after manual shutdown.

8.2 Pilot operation completion

The following procedures shall be carried out after the PBD is normally in operation.

Step 1: Inspect whether abnormality exists in PBD, such as excessive noise, excessive heat, abnormal smell or smoke.

Step 2: Measure whether voltage and current are stable.

Step 3: Operate LCD and check whether its working display is normal and accurate.

Step 4: Test whether the system is running in assistance with the preset operation logic.

Until now, the PBD pilot operation process has been completed and can enter into the daily operation and maintenance process.

8.3 Power off steps



CAUTION!

After the PBD is completely powered off, the machine is still electrified. If operations are needed, please be sure to cut off the outer power completely, and wait for not less than 5 minutes.

1. Click the OFF button to turn off the machine;
2. Cut off DC SWITCH PV input and Battery input;
3. Cut off AC SWITCH AC input and AC output;



CAUTION!

It is normal for the PBD to give alarm during power off. The power down steps can be continued.

9 Routine maintenance

9.1 Regular maintenance

9.1.1 Maintenance and repair



CAUTION!

All maintenance and repair operations can be performed on PBD only when it is safely disconnected from PV module, battery and power grid, and it is confirmed that these power supplies will not be connected again and wait for at least 5 minutes.

Only professional technicians familiar with the system operation can perform such operation.

> Disconnect the circuit breaker

Turn off the PV input and battery input switches to disconnect PBD with PV module and battery, And operate the output switch to disconnect the PBD from external power source. Make sure the PBD is not accidentally reconnected. Using a multimeter to test, make sure the device is disconnected and voltage free. Even if the PBD has been disconnected from the main power supply, battery and PV module, some components (such as capacitors) in the PBD still have residual voltage and discharges slowly. Therefore, after the circuit breaker is disconnected, please wait at least 5 minutes and use multimeter to measure and confirm the safety before continuing the operation.

➤ Maintenance and modification

Only personnel authorized by ATESS can maintain and modify the PBD. To ensure personal safety, please use only the original components provided by the manufacturer. Otherwise there will be no guarantee on compliance with relevant certification standards in terms of electrical safety, EMC, etc.

➤ Function and safety parameters

Do not change the parameters of PBD without the authorization of the local power supply company or without the instruction of ATESS. Unauthorized change of functional safety parameters may cause injury and damage to personnel or PBD, in which case, ATESS will not provide warranty services.



CAUTION!

1. After power on, wait for 5 minutes to confirm safety before carrying out maintenance work.
2. Use multimeter to measure, ensure the safety before disassembling.

9.1.2 Replace the dust screen

During the use of inverter, the dust on the top shall be cleaned regularly, and the dust screen at the air inlet shall be cleaned or replaced. During the replacement of the dust screen, the inverter shall be powered off.

Replacement method of dust screen: The dust-proof filter cotton on the door panel can be directly pulled up for cleaning and replacement.



In order to ensure the normal operation of inverter, it is necessary to clean the dust screen regularly.

9.1.3 Regular maintenance

In order to ensure the normal operation of the PBD, regular maintenance work is required.

Recommended routine maintenance cycle and work, as shown in Table 7-2.

Maintenance item	Cycle
Read data from data logger	every month
clean heat sink of the power module	every month
Check the dust, moisture or condensation inside the cabinet	every month
Check the cable connections, and fix the screw if necessary	every month
Check the warning label, add or replace some if necessary	every month
Manual checks AC and DC circuit breakers	every month
Check that the emergency stop button, and the LCD stop function	every month
Check if there is abnormal sound when inverter is operating	every week
Check if the battery is abnormal, bulging or smoking	every day

Figure7-2 Routine maintenance work



CAUTION!

All maintenance operations must be carried out in the condition that DC side of the PBD, corresponding switch of battery and PV module are all disconnected. Maintenance must be proceeded only after AC and DC disconnected for at least 5 minutes, in order to avoid electric shock!

9.2 Waste disposal

PBD will not cause environmental pollution, since the all the components meet the requirements of environmental protection. According to environmental protection requirements, user shall dispose the inverter in accordance with the relevant laws and regulations.

10 Appendix

10.1 Specification

Note: PBD250 does not include battery pack, and the output is connected to PCS DC side or battery; PBD350 has battery, and the output is connected to PCS DC side or battery;

Model	PBD250	PBD350
Input(PV)		
Recommended PV power (KW)	250	350
MPPT voltage range (V)	450~900	800~1300
Max.input current (A)	500 (100*5)	480 (240*2)
MPPT number	5	2
Battery (PBD350)		
Battery voltage range (V)	None	650~900
Battery type	None	Lithium/lead-acid
Max. Charging/discharging power (KW)	None	350
Max. Charging/discharging current (A)	None	538
Output (Battery)		
Battery voltage range (V)	600~850	550~800
Battery type	Lithium/lead-acid	Lithium/lead-acid
Max.discharging power (KW)	250	350
Max.discharging current (A)	416	500

Note: when PBD250 is configured with PV and battery, pay attention to the voltage difference between the front and rear stages. The PBD250 is a primary step-up circuit. The open circuit voltage of PV needs to be lower than the lowest discharge point of the battery to ensure that the voltage of the front stage is not higher than that of the rear stage. PBD350 is a two-stage step-down circuit. The minimum voltage of PV is higher than the maximum voltage of battery, and the minimum voltage of battery is higher than the maximum output voltage. Try to ensure that the front stage voltage is higher than the rear stage.

10.2 Ates Factory warranty

> Warranty period

The warranty period of this product is one year. If otherwise specified in the contract, the contract shall prevail.

During the warranty period, the customer shall show the invoice and date of purchase to the service personnel of ATESS. At the same time, the nameplate mark on the product shall be clear and visible, otherwise, ATESS has the right not to provide warranty service.

> Warranty conditions

In the event of failure during the warranty period, ATESS will repair or replace the product free of charge; The failed machine shall be owned by ATESS; the customer shall Set aside some time to repair the faulty machine.

> Liability exemption

In case of the following circumstances, ATESS has the right not to conduct warranty:

Products without logo of ATESS Power Technology logo;

The product or component that has exceeded the valid warranty period of ATESS;

Failure or damage (such as high temperature, low temperature, too wet or dry, high altitude, unstable voltage or current, etc.) caused by working in beyond-specified environment or wrong installation, storage or use that violates the instructions;

Failure or damage caused by unauthorized installation, repair, modification or disassembly;

Except for those authorized by the after-sales center of ATESS;

Failure or damage caused by using components that not supplied by ATESS;

Failure, damage or transportation damage caused by accident or human factors (operation error, scratching, carrying, bumping, improper voltage connection etc.); ;

Failure or damage caused by force majeure (such as earthquake, lightning, fire etc.);

Failures or damages caused by other factors rather than quality problems of the supplied product itself(including components).

10.3 Contact

If you have technical problems concerning our products, contact your installer or ATESS. During inquiring, please provide below information:

- Inverter type
- Modules information
- Communication method
- Serial number of Inverters
- Error code of Inverters
- Display of inverters